

PROGETTO: LAVORI OCCORRENTI PER LA COSTRUZIONE DI UNA ROTATORIA A RASO AL KM 386 + 00 SULLA SS. N° 18 "TERRENA INTERIORE" IN LOCALITA' "ACCONIA DI CURINGA"

PROGETTO ESECUTIVO

DITTA : COMUNE DI CURINGA
UBICAZIONE: ACCONIA-MARE

I PROGETTISTI & COORDINATORI PER LA SICUREZZA IN FASE DI PROGETTAZIONE:

ING. GIUSEPPE GULLO
ING. GIACINTO LORUSSO
GEOM. ANTONIO DI BELLA

ELABORATO:PARTICOLARI COSTRUTTIVI CANALE SCOTOLARE
DA FOSSEO S. EUPRASIO AL PUNTO "A" - SCALA 1:100

TRV. INT. 2/5

PIANTA FINIZIONE

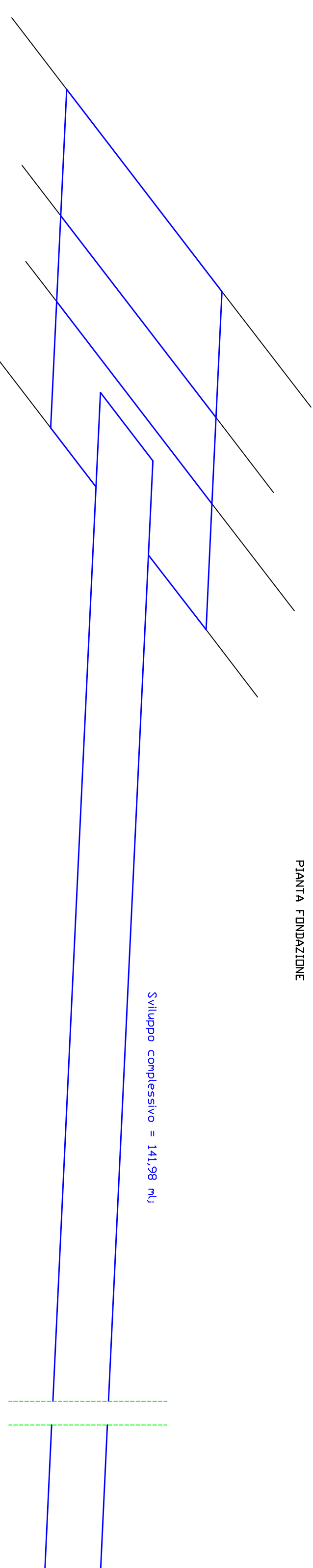

PROSPETTO CIGLIO ESTERNO E CIGLIO INTERNO

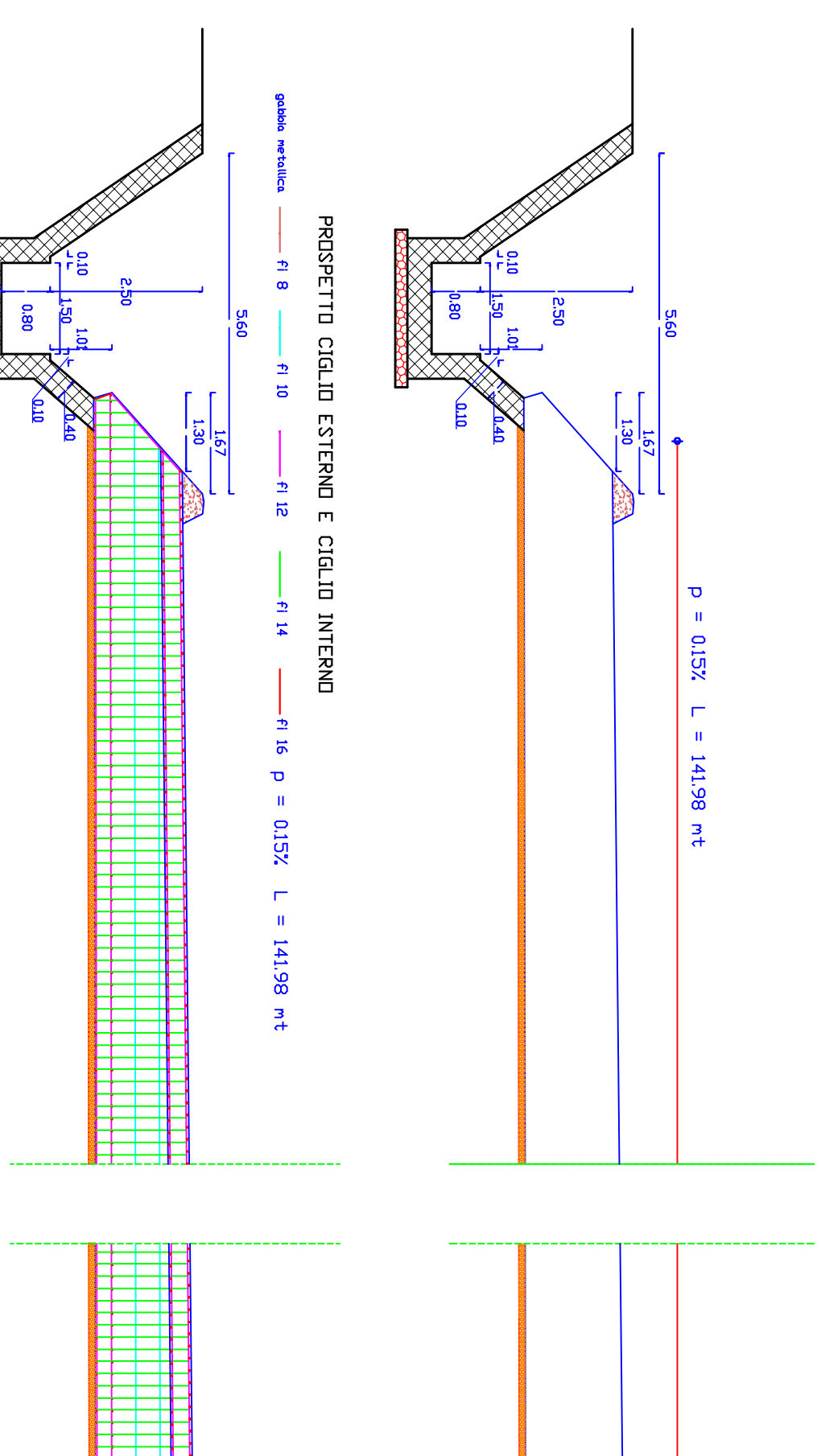

PIANTA FINIZIONE

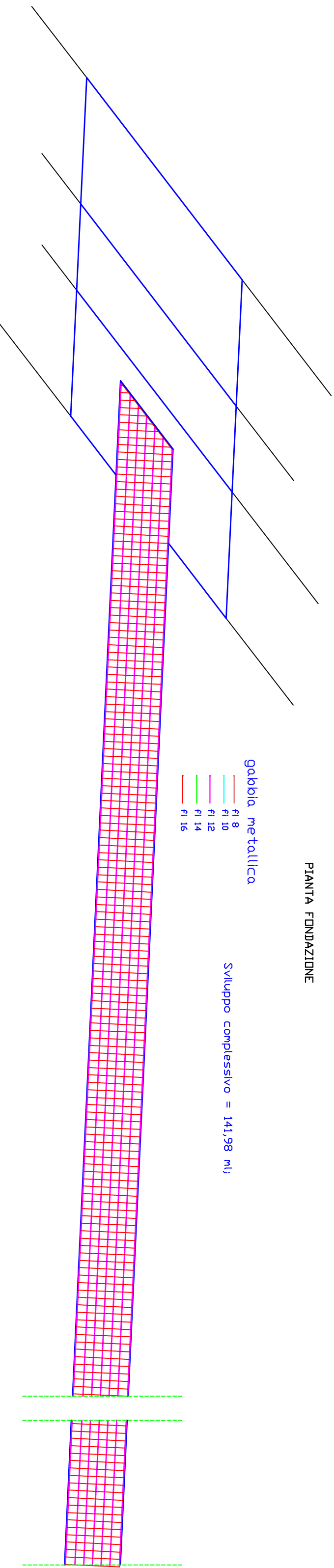

PIANTA FINIZIONE



PIANTA FINIZIONE

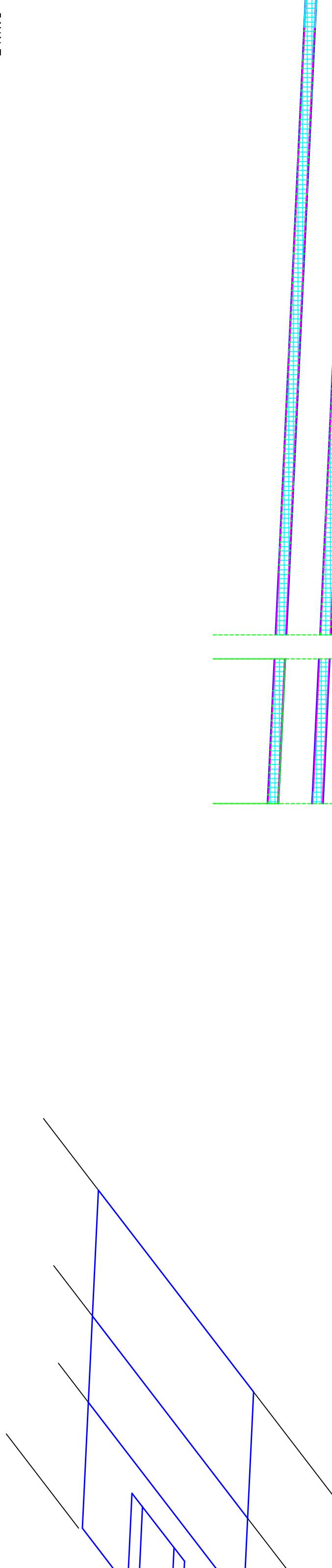

PIANTA FINIZIONE

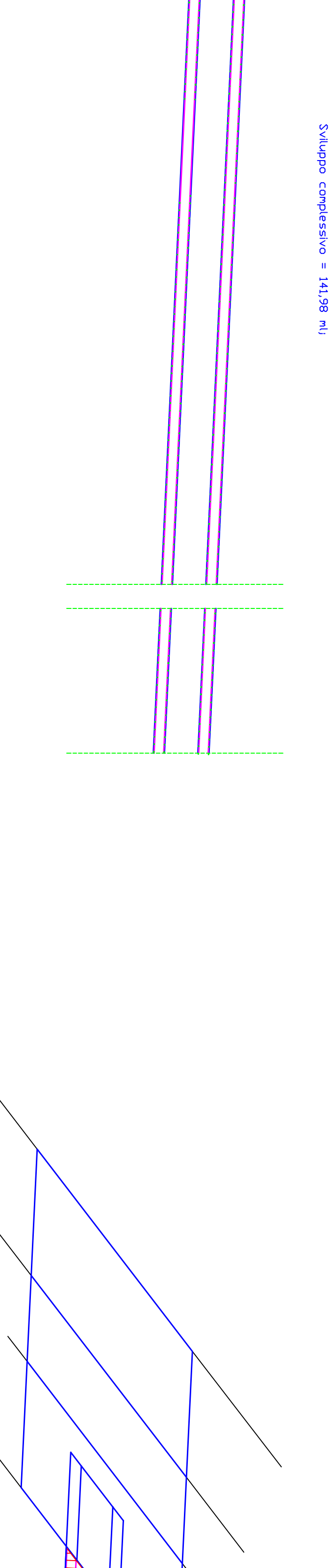

PIANTA FINIZIONE

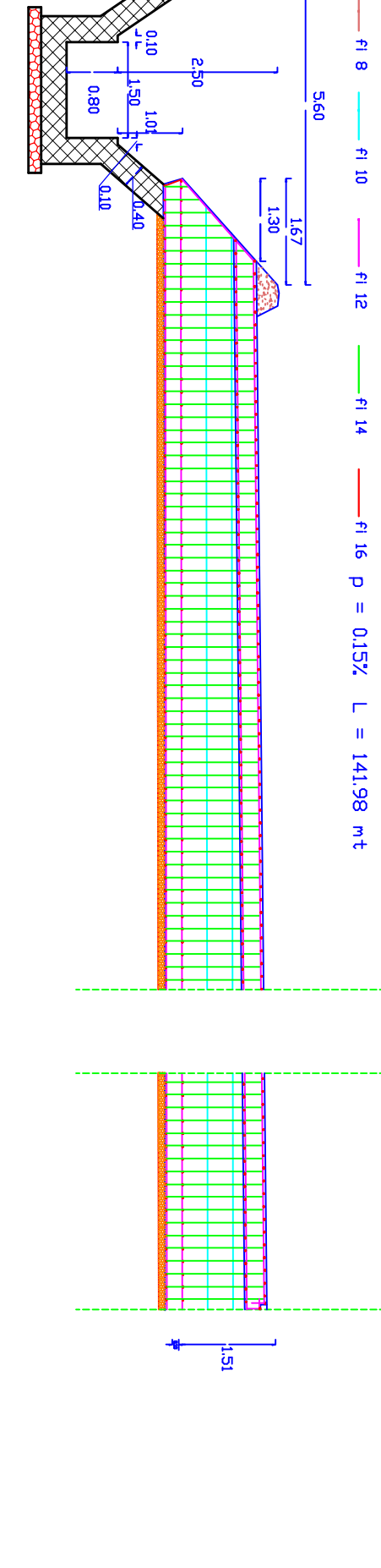
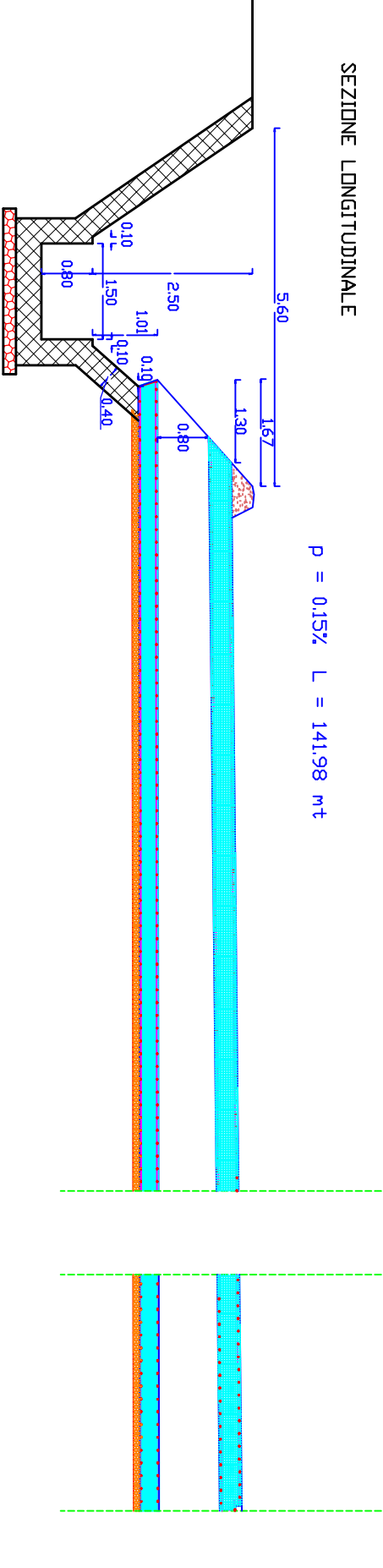
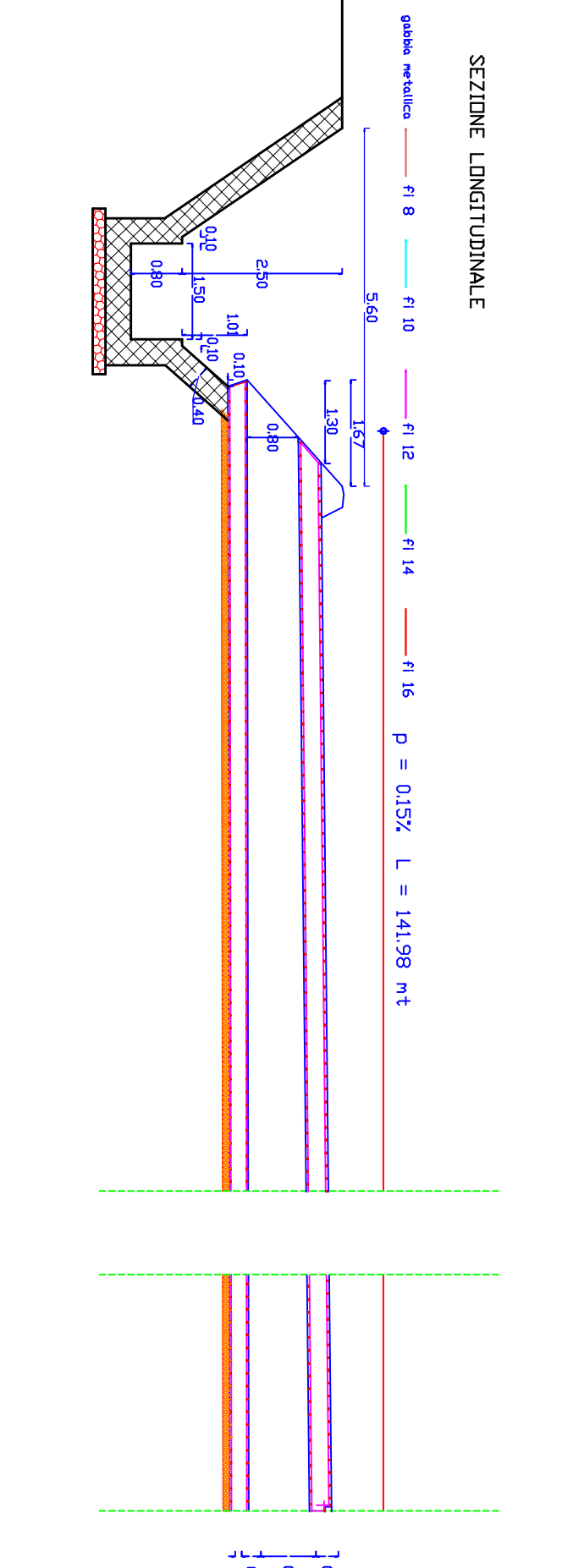

PIANTA FINIZIONE

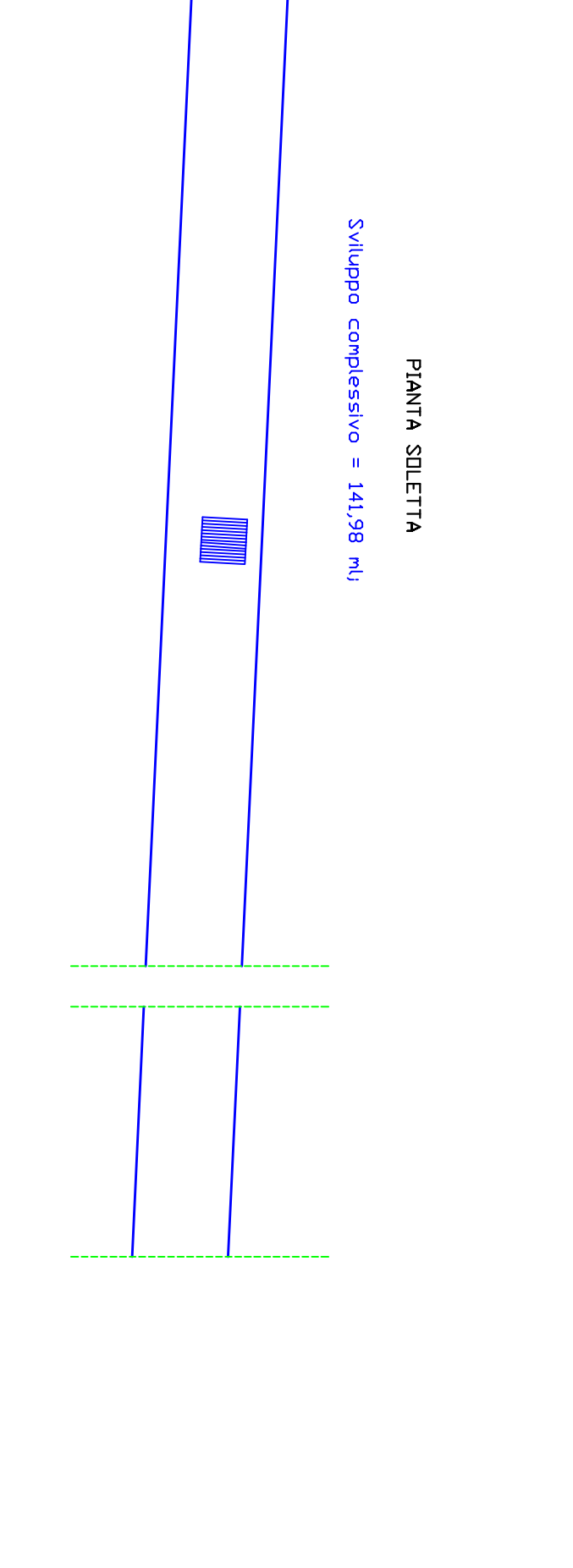

PIANTA FINIZIONE

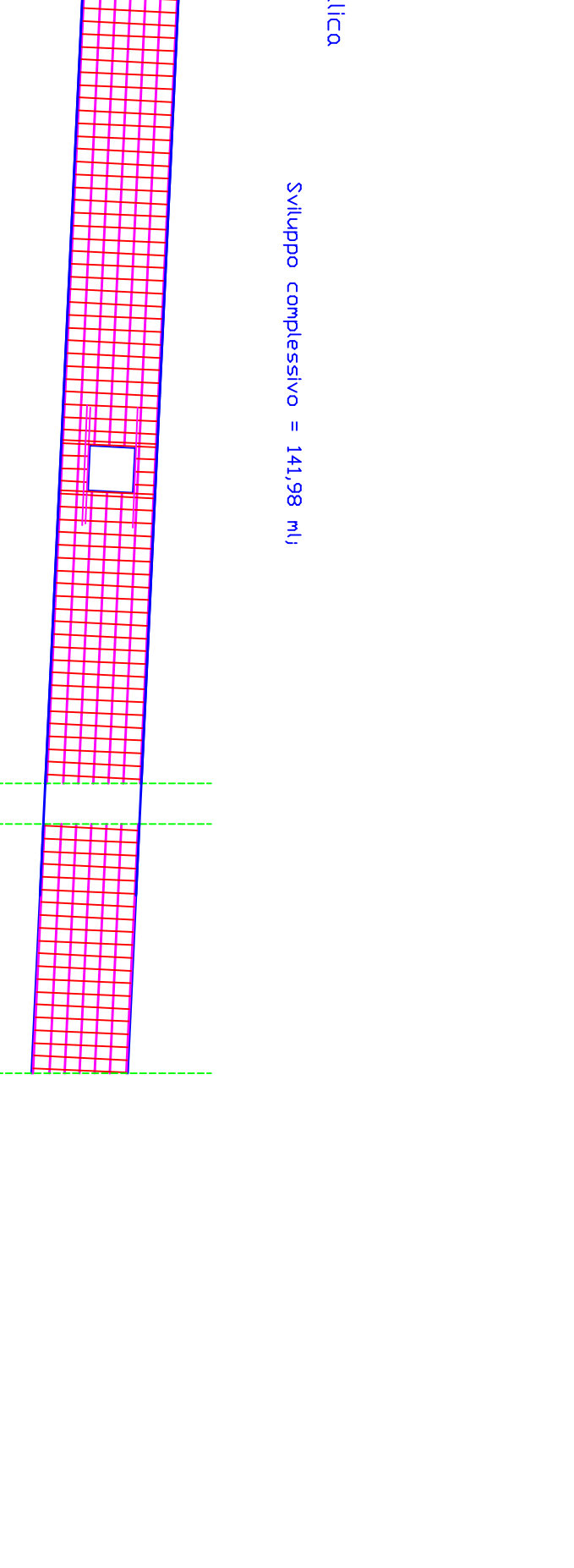

PIANTA FINIZIONE

GABBIO METALLICO SECONDO PER IL CANALE - scala 1:50

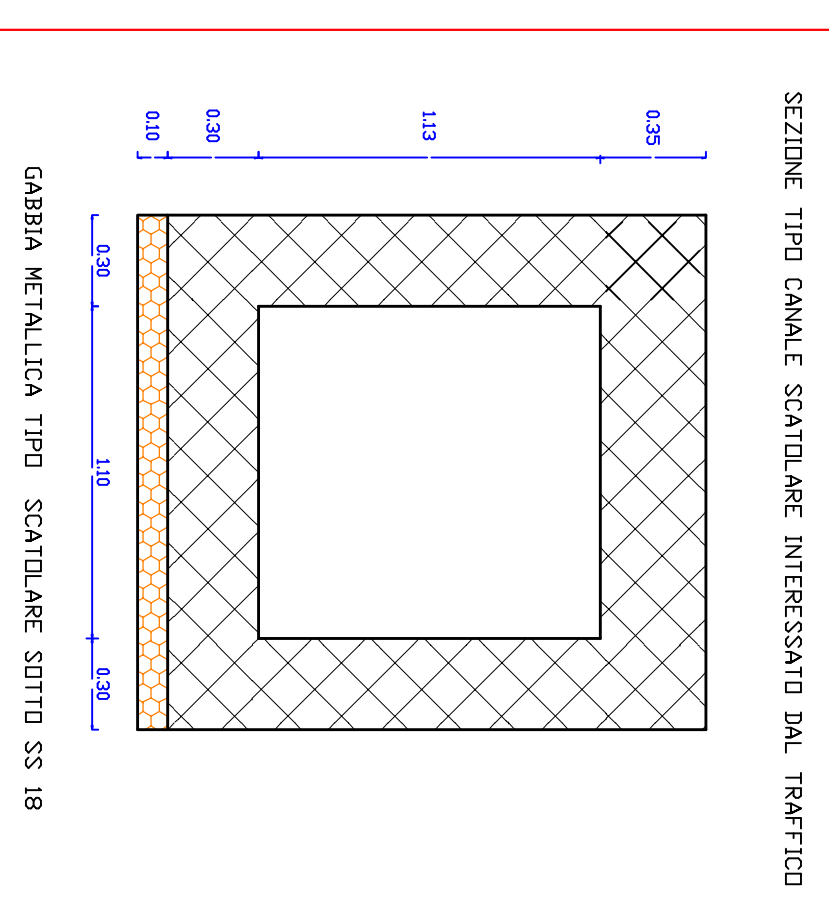

GABBIO METALLICO SECONDO PER IL CANALE - scala 1:50

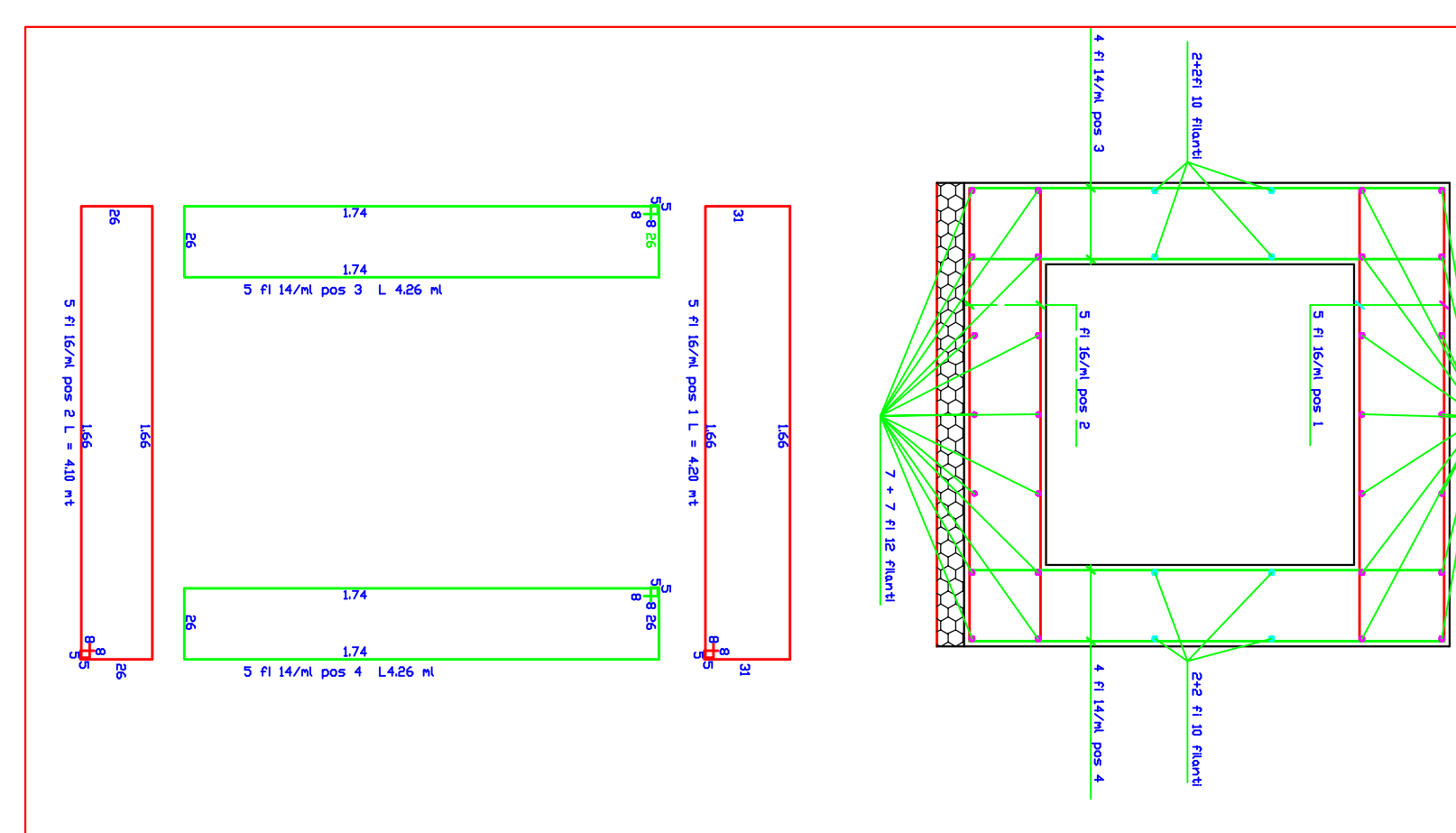

SEZIONE TRASVERSALE FOSSEO S. EUPRASIO (Situazione attuale)

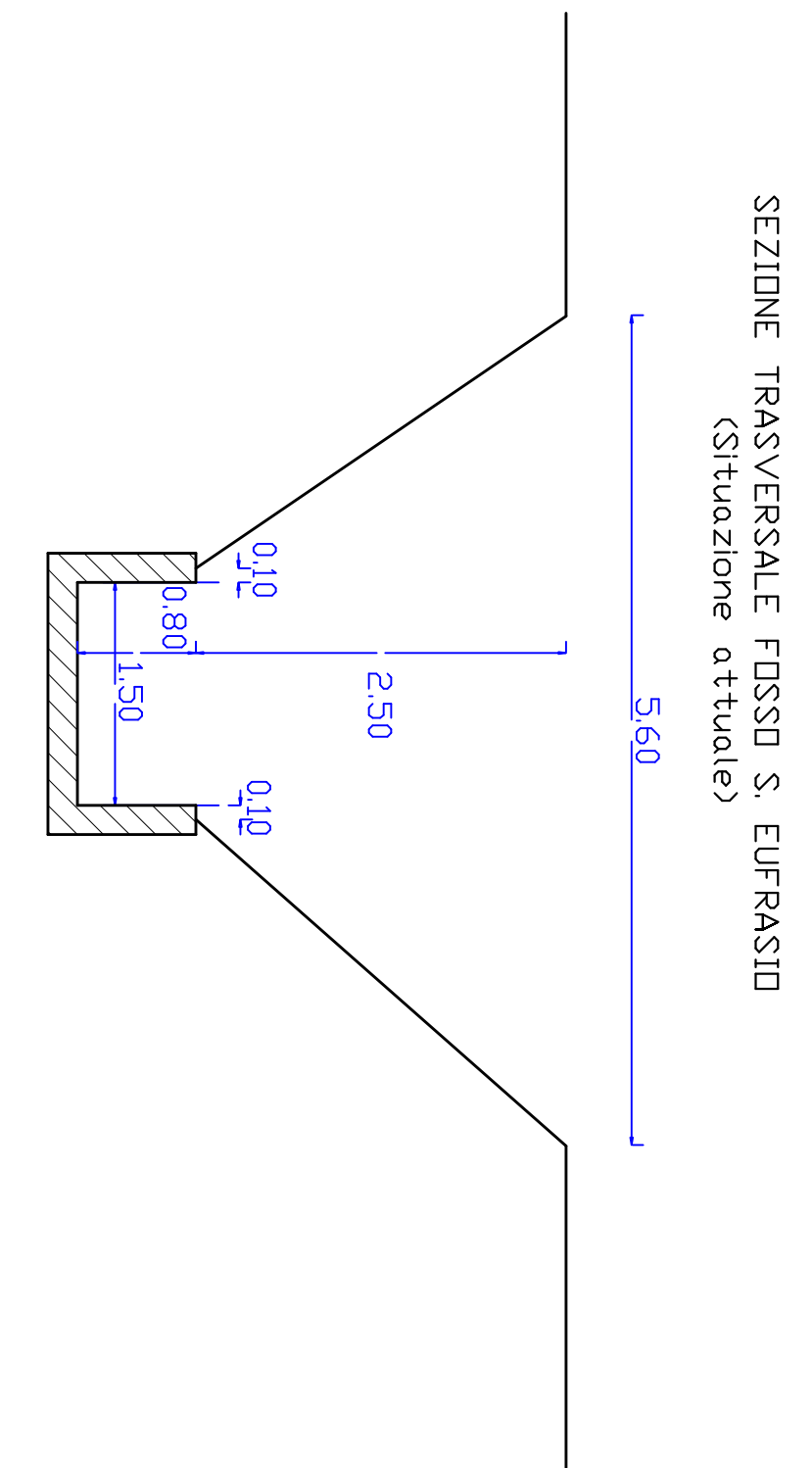

SEZIONE TRASVERSALE FOSSEO S. EUPRASIO (Situazione di progetto)

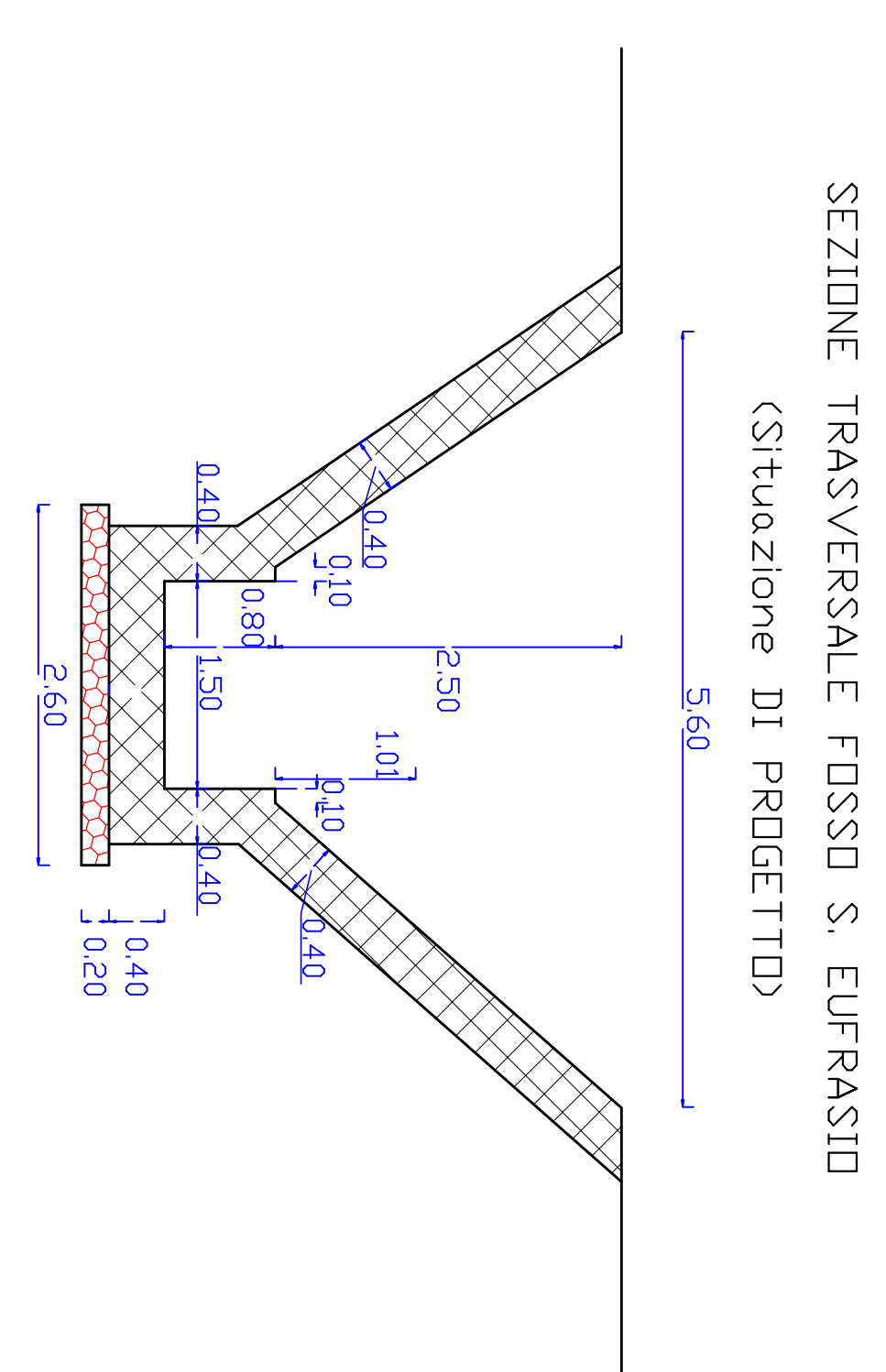

SEZIONE TRASVERSALE FOSSEO S. EUPRASIO (Situazione attuale)

